

**Anritsu** Advancing beyond

# Optical Spectrum Analyzer

## MS9740B

600 nm to 1750 nm



# 4TECT

ООО «4ТЕСТ»

Телефон: +7 (499) 685-4444

info@4test.ru

www.4test.ru

# Increased productivity

## MS9740B Optical Spectrum Analyzer



Reduce the measurement processing times by up to half compared to the earlier model while assuring high performance and complete test menus brings higher-efficiency inspection of active optical devices.

## Ideal All-in-One Design for Active Optical Device Evaluation

With all functions and performance needed for evaluating active optical devices, including optical transceivers, VCSEL, DFB light sources, etc.

- Wavelength sweeping time  $<0.35 \text{ s}^{*1}$
- Maximum wavelength sweeping time  $<0.2 \text{ s}^{*2}$
- All-in-one function (MM mode) supporting SM and MM fiber  $^{*3}$
- Supports LC connectors (using adapter)

\*1: Typical. value. Reduce the sweep time by 50% compared to previous models. VBW: 1 kHz\_Fast, Resolution: 0.1 nm, Sweep Width: 30 nm, Sampling point: 1,001

\*2: VBW: 10 kHz, Resolution: 0.1 nm, Sweep Width: 5 nm, Sampling point: 501

\*3: The MS9740B-009 Multimode Fiber Interface option is designed for multimode connections to the optical input section; it supports measurements with high optical sensitivity and high sweep speeds when using a MM fiber with a core diameter of  $62.5 \mu\text{m}$  and a NA of  $\leq 0.275$ . Although the MS9740B-009 option can also be used to measure SM fiber, some features are different from the standard MS9740B model. For details refer to the MS9740B and MS9740B-009 specifications.

\*4: GPIB Interface, SMSR Measurement Time (DFB Light Source), VBW: 1 kHz\_Fast (MS9740B)/1 kHz (MS9740A) Setting, 0.1-nm Resolution, 30-nm Sweep Width, 1001 Sample Points

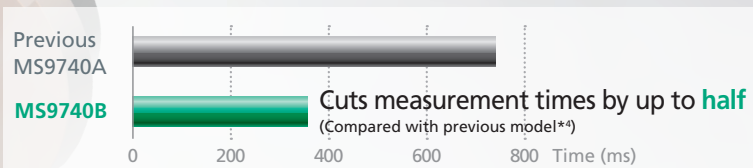

## High Resolution and Wide Dynamic Range

Supports signal evaluation requiring wide dynamic range and high resolution, such as OSNR analysis of WDM signals.

- Dynamic range  $>58 \text{ dB}$  (at  $\pm 0.4 \text{ nm}$  from peak wavelength)
- $-90 \text{ dBm}$  lowest optical sensitivity
- $30 \text{ pm}$  minimum resolution
- $\pm 20 \text{ pm}$  wavelength accuracy (C/L band, at wavelength calibration using wavelength calibration light source)
- Supports signal level integration function supporting modulation signals
- Accurate noise position estimation using noise fitting function
- Supports optical axis alignment, wavelength calibration, effective resolution calibration functions

## Facilitates Stable Production of High-output LDs

Facilitates high SMSR reproducibility without impacting production efficiency at optical pulse measurement under asynchronous conditions without trigger-signal input.

- $\pm 1.4 \text{ dB}$  SMSR reproducibility  $^{*5}$

\*5: With MS9740B-020 option installed but  $\pm 1.8 \text{ dB}$  when choosing Multimode Fiber Interface MS9740B-009. Refer to the MS9740B-020 specifications page or page-5 summary for the measurement conditions.

## Supports Nine Application Modes

Efficient fast measurement is assured by complete menus containing all test items required by various applications plus all-at-once analyses with best items.

Application Name	Test Items
DFB-LD	Spectrum analysis of single longitudinal mode laser
FP-LD	Spectrum analysis of multiple longitudinal mode laser
LED	Spectrum analysis of wideband light source
PMD	PMD characteristics evaluation of optical fiber
Opt. Amp	Evaluation of fiber amp (EDFA) gain and NF characteristics
Opt. Amp (Multi-channel)	
WDM	Spectrum evaluation of WDM for up to 300 wavelengths (channels)
LD Module	Evaluation of optical transceiver characteristics
WDM Filter	Analysis of optical bandpass filter

# Optical Spectrum Analyzer MS9740B Various Measurement Applications

## Fast and Easy Analysis

### Example of Optical Transceiver Measurement

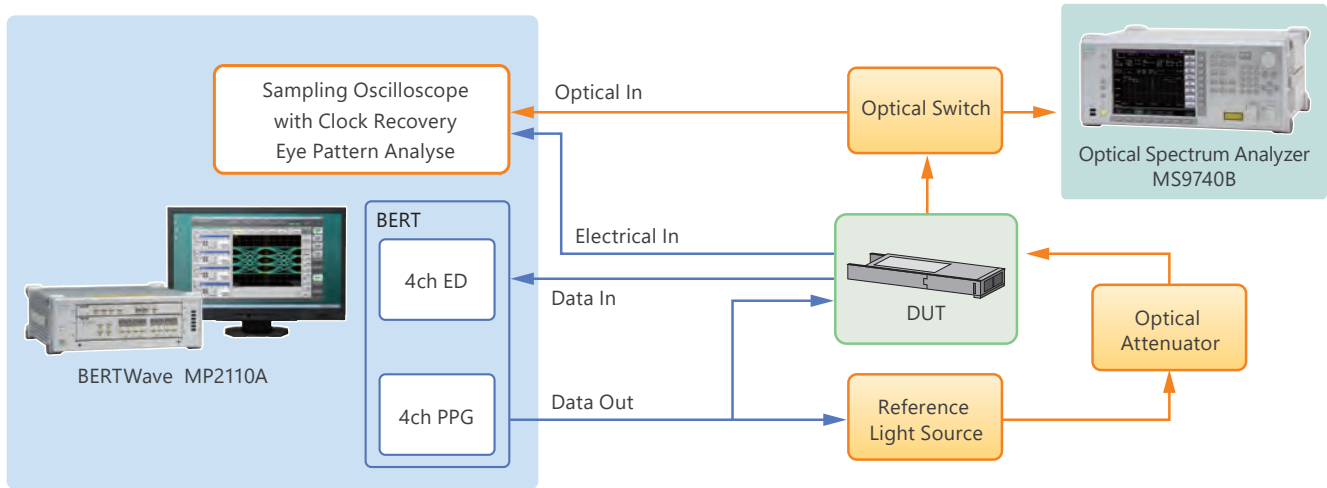

### LD Module Test Analysis

This application measures test items such as center wavelength, optical level, OSNR, etc., required for LD module tests, and displays the results on one screen. The center wavelength, optical level, OSNR (per nm), side mode suppression ratio (SMSR) and 20 dB down spectrum width of LD modules can be measured. The center wavelength and spectrum half-width (FWHM) of FP-LDs or VCSELs are measured using the RMS method. Both SM and MM fibers are supported by one unit, helping cut equipment costs.



#### LD Module Test Items

- Center wavelength, Level
- OSNR (actual measured value)
- OSNR (noise level per nm)
  - \* OSNR noise level specified from Higher, Left, Right, (L+R) / 2 or distance from peak wavelength
- SMSR
- Side mode peak wavelength, Level
- Spectrum width (n dB, RMS method, Standard deviation)

LD Module Test

### LD Chip/CAN Device Evaluation

Evaluation systems for LD Chip/CAN devices must support efficient measurements of multiple devices and two key factors are short evaluation time as well as fast optical axis alignment time for each device. For example, irrespective of the LD type, optical axis alignment using MM fiber for receiving radiated light in a short time with good efficiency requires a lot of time consuming work. In this case, the optical spectrum analyzer finally receiving this light must also have the lowest possible connection loss and excellent high-speed sweep performance for waveform analysis. With a built-in Fast mode, the MS9740B supports both a wide dynamic range and high-speed measurement at Rx optical bandwidths (200 Hz and 1 kHz) used most commonly by optical-device production lines. At the same Rx optical bandwidth setting, it retains the same measurement sensitivity as its MS9740A predecessor while cutting measurement times by 50% for better production efficiency. The Multimode Fiber Interface option MS9740B-009 is ideal for evaluating optical devices mainly using this type of MM fiber. The MS9740B-009 optical receiver section is optimized for MM fiber connections. Since extremely accurate sensitivity settings (VBW) are supported, MM fiber connection loss is kept to a minimum and the characteristics of multiple devices can be evaluated efficiently because the optimum sensitivity for level and SMSR measurements as well as high-speed sweeping conditions are both assured. In addition, the MS9740B-009 has high resolution even in the short wavelength band, and offers optimized applications for VCSEL, etc., evaluations.

# Optical Spectrum Analyzer MS9740B Various Measurement Applications

## Fast and Easy Analysis

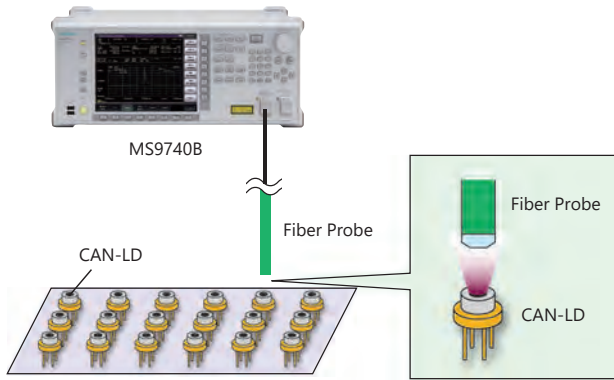

Example of Device Characteristics Evaluation

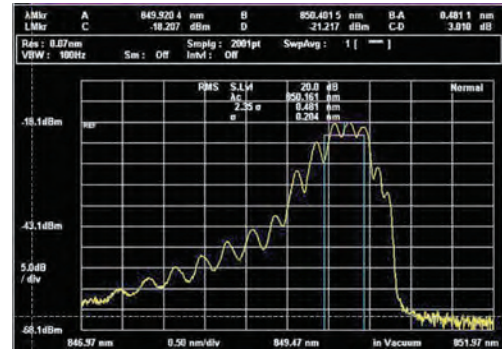

850 nm VCSEL Spectrum Measurement Example

### Supports Optical Pulse Measurement Function for Thermal Countermeasures at LD Chip Production Testing

With production of high-bit-rate LDs supporting recent deployment of high-speed networks, thermal countermeasures at LD chip production have become an issue in both communications and non-communications fields. There is increasing demand for spectrum measurement using pulsed optical input as a solution to this issue.

Generally, accurate spectrum measurement of optical pulse signals uses synchronization with an input trigger signal. However, since the sweep speed is relatively slow compared to CW measurement that does not require synchronization, this measurement using a trigger signal is especially problematic due to the importance of tact time at manufacturing and inspection.

Using the MS9740B with installed Option 020 (MS9740B-020) in the optical pulse measurement mode supports measurement of the LD pulsed optical spectrum without requiring input of a trigger signal in a similar time to that required for CW optical spectrum measurement under asynchronous conditions. Additionally, the key SMSR parameter evaluation achieves a high measurement reproducibility of  $\pm 1.4$  dB<sup>\*5</sup>.

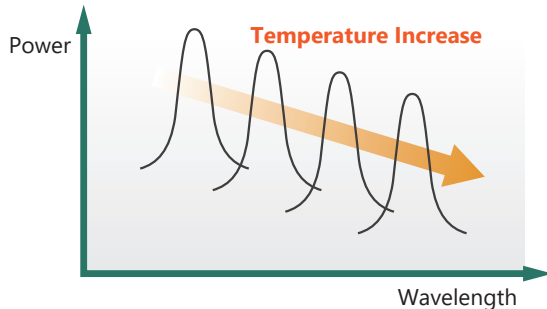

Change in Spectrum with Temperature Increase

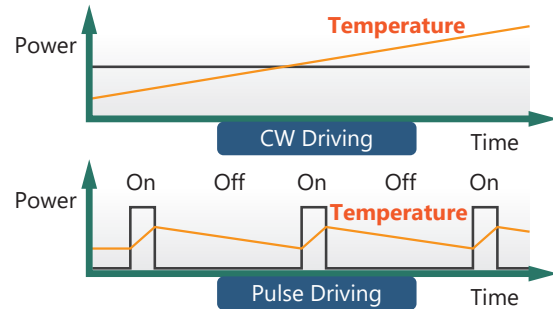

Change in Temperature at CW and Pulse Driving

\*1: With MS9740B-020.

$\pm 1.8$  dB with Multimode Fiber Interface MS9740B-009 installed  
Using SM fiber and DFB-LD with 1550 nm wavelength at 10 dBm peak power input, with 45 dB max SMSR and no change in polarization conditions  
Pulse conditions: 5 kHz min repetition frequency and 1% min Duty  
Pulse Mode enabled, 1 kHz VBW, 0.1 nm Setting Resolution, 10 nm max span, 501 sampling points, at 23C $\pm$ 5C

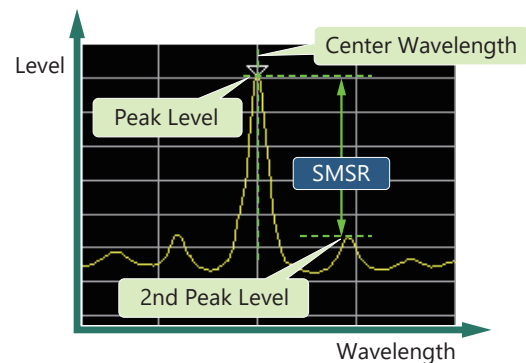

SMSR Measurement

The wavelength sweep time changes according to the VBW and measurement wavelength range; the relationship is shown in the following table.

### Relationship between VBW, Sweep Time, and Minimum Optical Reception Sensitivity<sup>\*2</sup>

VBW	10 Hz	100 Hz	200 Hz	1 kHz	2 kHz	10 kHz	100 kHz	1 MHz
Sweep Time (typ.) <sup>*3</sup>	32 s	3.5 s	2 s	0.5 s	0.3 s	0.2 s	0.2 s	0.2 s
Fast Mode <sup>*3</sup>	—	—	1 s	0.25 s	—	—	—	—
Min. Optical Reception Sensitivity <sup>*4</sup>	-90 dBm	-80 dBm	-76 dBm	-70 dBm	-66 dBm	-60 dBm	-50 dBm	-40 dBm

\*2: Reference value and not guaranteed.

\*3: Center wavelength: 1200 nm, Span: 200 nm, No. of samples: 501, Normal dynamic range, Point Avg. 1, No optical input, Sweep start to end

\*4: Wavelength range: 1250 nm to 1600 nm, Resolution: >0.07 nm, Optical attenuator OFF, Sweep Avg. 10, SM fiber is used, 5C to 30C

# Optical Spectrum Analyzer MS9740B Various Measurement Applications

## Analyze 100 GHz and 50 GHz Spaced WDM Signal at Once

### WDM Application

The 42 dB dynamic range at 0.2 nm from the peak wavelength supports accurate WDM signal measurement at 100 and 50-GHz intervals. Up to 300 channels can be evaluated and data required for WDM signal analysis, such as center wavelength, level, SNR, etc., are displayed on one screen. Specification of the noise location, which is required at OSNR analysis, can be selected using two estimation methods; 2-point interpolation, and noise fitting interpolation of a specified noise area. The 2-point interpolation method auto-analyzes the Dip point between each channel, but the distance from the center wavelength can be specified. It can be difficult to estimate noise accurately if the noise is not flat and the edges of the spectrum appear to overlap at adjacent channels. In these cases, accurate OSNR measurement is impossible, but analysis by noise fitting is effective. Either of the two MS9740B noise fitting methods — specification of the noise area for each WDM signal channel, or user-specification of the noise area — can be selected. Sufficient measurement dynamic range must be secured to measure noise position accurately for OSNR measurements. Consequently, a high resolution setting is required, but when measuring the level of a wide spectrum signal with modulation, the level cannot be measured accurately when measuring the spectrum peak at high resolution. To resolve this contradiction, the MS9740B has a built-in signal integration function that accurately measures signal level by integrating the signal even at high resolution.

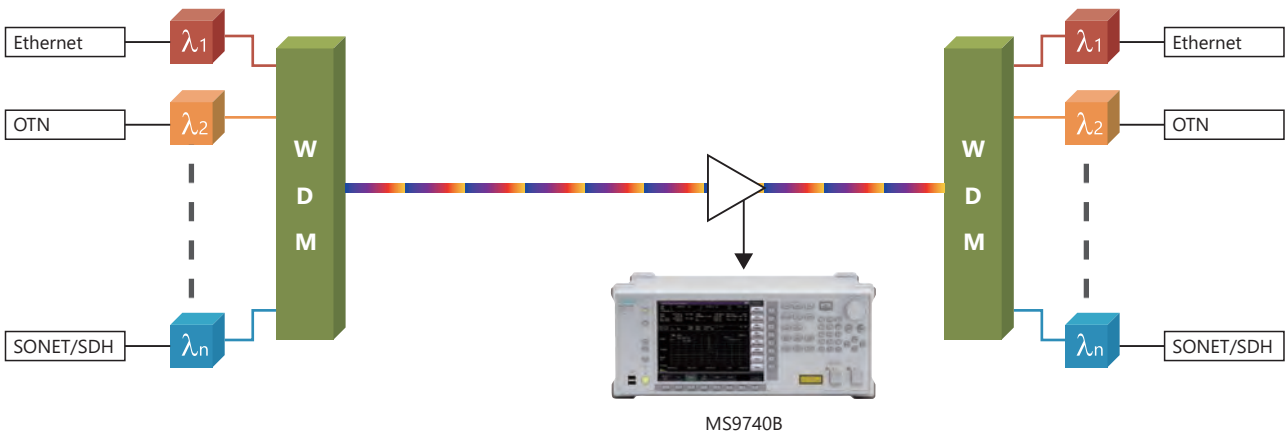

WDM Signal Analysis

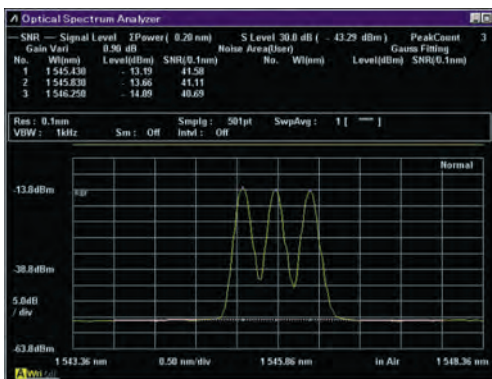

OSNR Measurement using Noise Fitting (Noise area specified by user)



Example of Spectrum with Level Analysis by Signal Integration Method

# Optical Spectrum Analyzer MS9740B Various Measurement Applications

## Analyze 100 GHz and 50 GHz Spaced WDM Signal at Once

### EDFA Analysis Application

The gain characteristics and Noise Figure (NF) are key optical fiber amplifier performance indices. The MS9740B calculates the gain and NF automatically from the optical input and output to the optical fiber amplifier. It supports two EDFA measurement applications: Opt. Amp (Multi-channel) for WDM signals and the latest IEC standards.

### Opt. Amp Application Analysis

The Amplitude Spontaneous Emission (ASE) level is measured either by pulse measurement, interpolation using fitting, or polarization nulling.

### Opt. Amp (Multi-channel) Application Analysis

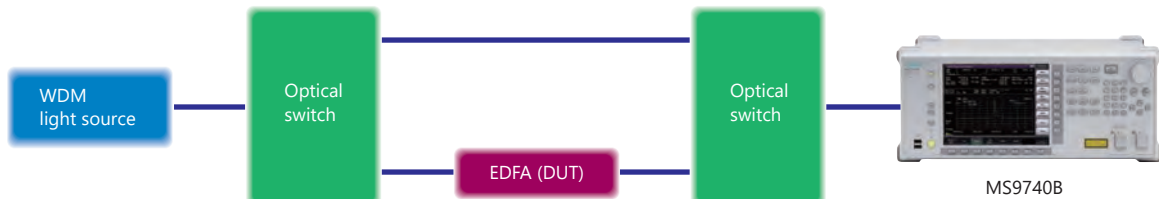

The optical fiber amplifier gain and NF characteristics are different when using a single light source or WDM signals.

When assuming actual WDM transmission, it is extremely important to perform optical fiber amp analysis using a WDM signal as the measurement signal and this EDFA analysis measurement mode supports WDM signals. The IEC-recommended ISS (Interpolated Source Subtraction) method is supported for gain and ASE analysis, and a mode for automatically detecting the noise position is also provided.

The Gain Variation and the Output Slope analysis are also supported within the same application.



Example of Opt. Amp (Multi-channel) Analysis Function Measurement

# Optical Spectrum Analyzer MS9740B Various Measurement Applications

## Easy Reference Measurement of Optical Filters using Waveform Difference Display

### Example of Narrow-band Filter Measurement

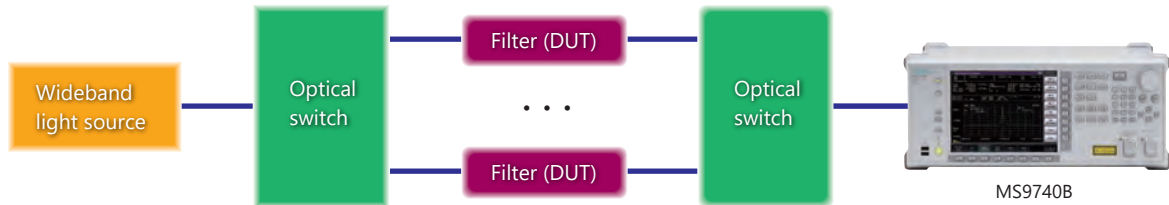

### Narrow-band Filter Analysis using Trace Application

Evaluation of passive devices, such as FBG, AWG, OBPF, etc., uses a wideband light source. The variance between results with and without (reference measurement) the DUT is measured to evaluate the DUT characteristics. The MS9740B has a large waveform memory for saving up to 10 waveforms and a wavelength difference calculation function making it easy to evaluate devices such as optical switches.

Evaluation of passive device also requires a wide dynamic range. The MS9740B is perfect for these evaluations because it has a wide dynamic range of 42 dB at 0.2 nm from the peak wavelength and 58 dB at 0.4 nm from the peak. Moreover, because minimum wavelength resolution is 30 pm and minimum light-reception sensitivity is -90 dBm, the MS9740B can easily evaluate the characteristics of narrow-band filters, etc. In addition, all 10 waveforms displayed on one screen can be saved in one file.

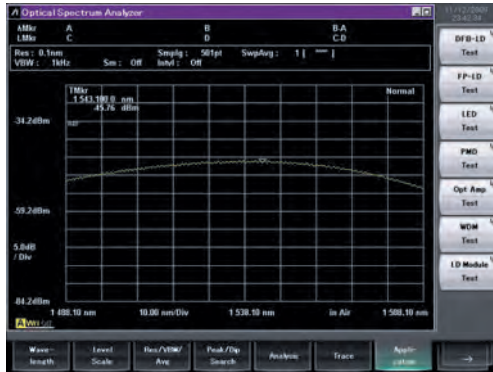

Wideband Light Source Waveforms

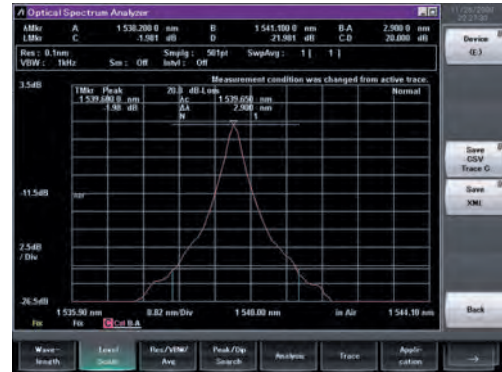

Filter Analysis by Waveform Difference Comparison



Multi-waveform Display



# Optical Spectrum Analyzer MS9740B Various Measurement Applications

## Easy Reference Measurement of Optical Filters using Waveform Difference Display

### WDM Filter Measurement Application

Fast evaluation of optical devices requires short inspection times using high-efficiency measuring equipment. The MS9740B adds a new WDM Filter analysis function supporting group display for optical bandpass filters, such as WSS and WDM Filter devices.

### Transmittance Evaluation

The WDM Filter analysis function supports efficient evaluation of optical bandpass filter transmittance characteristics.

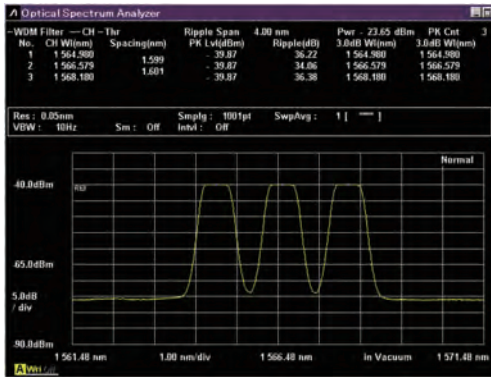

- WDM Filter Function Measurements**
- Signal Level
  - Peak Signal No.
  - Signal Wavelength
  - Spacing (Wavelength)
  - Pass Band
  - Ripple

### Insertion Loss Evaluation

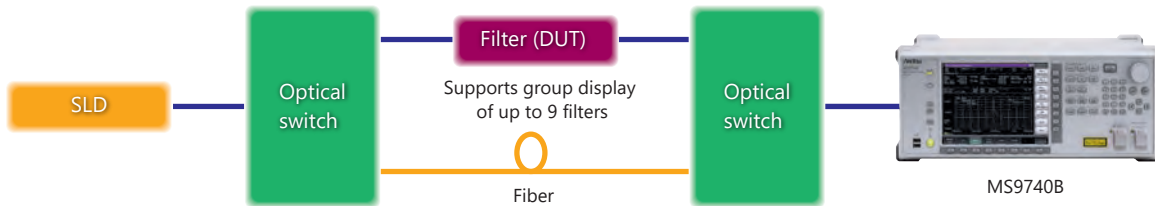

Filters, such as optical bandpass filters, are evaluated by finding the difference in the measured results when the filter (DUT) is inserted and not inserted. The MS9740B Trace Mode function supports measurement using optical switches to measure DUT insertion loss by inter-waveform processing, saving the results in one file and displaying up to 10 waveforms simultaneously on one screen.

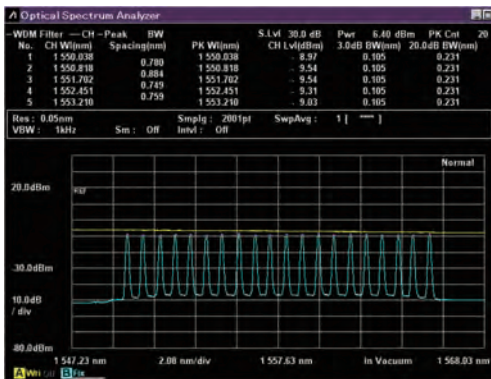

Waveform of Wideband Light Source Before and After Insertion to Optical Bandpass Filter

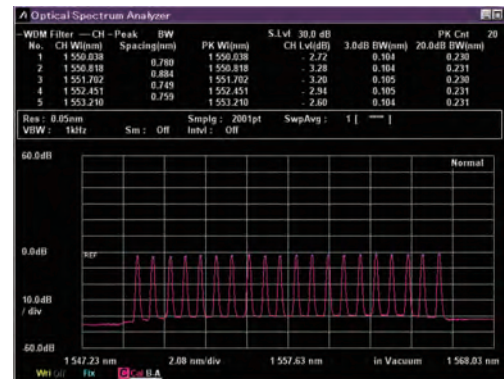

Filter Analysis by Waveform Difference Comparison

# Optical Spectrum Analyzer MS9740B Various Measurement Applications

## Easy Reference Measurement of Optical Filters using Waveform Difference Display

### SM/MM Fiber Support

At optical device evaluation and measurement, it is important to suppress the effect of reflections at the optical input section. The MS9740B achieves a reflection attenuation of 35 dB max. using a fiber input structure for high-accuracy spectrum measurement.

The Multimode Fiber Interface option MS9740B-009\* option also supports connection of SM fiber.

\*: The Multimode Fiber Interface option MS9740B-009 is designed for multimode connections to the optical input section; it supports measurements with high optical sensitivity and high sweep speeds when using a MM fiber with a core diameter of 62.5  $\mu\text{m}$  and an NA of  $\leq 0.275$ . Although the MS9740B-009 option can also be used to measure SM fiber, some features are different from the standard MS9740B model.

For details refer to the MS9740B and MS9740B-009 specifications.

### Various Trace Displays

In addition to the normal waveform displays, the MS9740B has a full range of flexible display modes including Max Hold for displaying peak levels at continuous sweeping, Min Hold for displaying dip level at continuous sweeping, Calculate for computing differences between traces, etc.

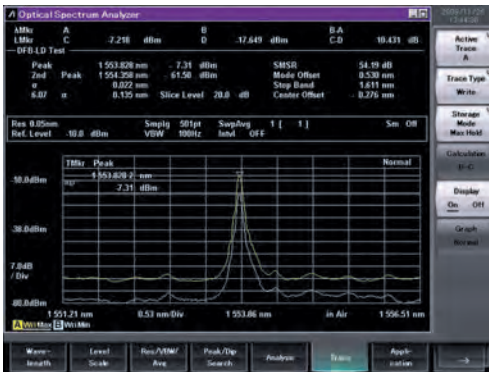

Max Hold, Min Hold Display Function

These display functions are convenient for confirming maximum and minimum levels at continuous sweeping.

The Overlap function superimposes all swept waveforms on one screen. It is ideal for checking the wavelengths of optical sources and long-term level drift.

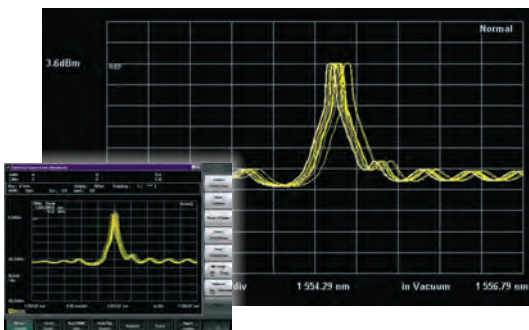

Overlap Display Function

### Using External Trigger

This measurement is supported by inputting an external trigger signal to the trigger input section at the MS9740B back panel.

### Wavelength Calibration Function for Accurate Measurements and Analysis

Assuring reliable measurement and analysis requires measurement with the best accuracy and resolution, which in turn requires automatic alignment of the internal optical axis, wavelength calibration with an external light source, and resolution calibration.

A wavelength accuracy of  $\pm 20$  pm is assured by calibrating the wavelength using the Light Source for Wavelength Calibration (MS9740B-002) after automatic optical axis alignment.

In addition, the MS9740B has a function for automatically calibrating wavelength if the ambient temperature and pressure change, based on the first calibration data. Calibration of effective resolution is important when measuring the noise level of a continuous spectrum, such as EDFA ASE, LDs, etc.

Item	Calibration
Automatic Optical Axis Alignment	Satisfy wavelength accuracy, level accuracy and dynamic range specifications
Wavelength Calibration	Calibrate wavelength using external light source and light source for wavelength calibration
Actual Resolution Calibration	Calibrate Actual resolution for accurate noise level measurement

# Optical Spectrum Analyzer MS9740B Various Measurement Applications

## For More Accurate Spectrum Analysis

### Screen Hard Copy

The built-in screen hard copy function dumps the screen image as a bmp or png file, which can be easily transferred to a PC via the Ethernet or GPIB interface using a remote command.

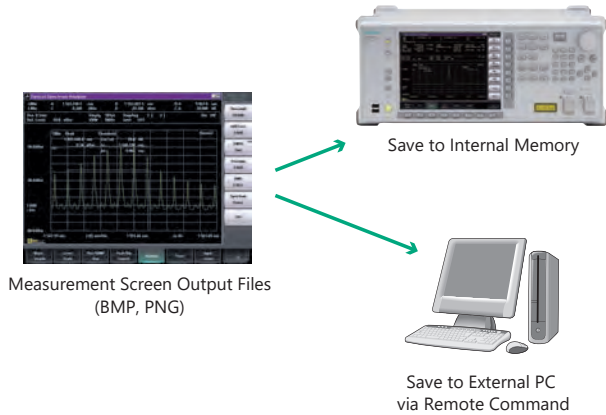

### Save 10,000 Waveforms to Internal Memory

Measured and analyzed data can be saved to internal memory. Up to ten waveforms (Trace A to J) can be saved in one file and up to 1000 files can be saved to internal memory. These files can be saved to USB memory as well.

### Six USB Ports

The six USB ports (two on front and four on rear) can be used to move data in internal memory to external USB memory while keeping a USB mouse and keyboard connected, making waveform analysis and file management easier than ever.

### Remote Control via Ethernet and GPIB Interfaces

Remote control is supported over either the Ethernet or GPIB (MS9740B-001) interfaces, slashing the time from measurement start at the MS9740B to data capture at an external PC via the GPIB interface.

\* NI-VISA™ is required separately.

### OS Recovery

The system can be returned to the default settings at factory shipment by the built-in OS recovery image. This is useful for recovering from Windows OS problems.

### Backward Compatibility with MS9740A/MS9710/MS9780 Series Remote Commands

Support for almost all remote commands used by the previous MS9740A, MS9710 and MS9780 series of instruments assures smooth backwards compatibility and easy future-proof migration to newer instruments.

### Remote Tool Package

The MS9740B Remote Tools Package supports easy creation of remote command sequences software.

The Remote Tools Package includes the quick-start guide, sample programs, C# class library, and LabVIEW driver.

Sample Programs: MS9740B control program created using Visual Basic  
C# Class Library: DLL using NET framework  
LabVIEW Driver: NI LabVIEW 7.1 driver

### VGA Output

The VGA connector displays measurement and setting screens on an external display for easy group viewing, etc.



### Compact and Low Power Consumption

Weighing in at under 15 kg, the MS9740B is lighter bench-top spectrum analyzer. Consuming under 75 VA, it's also eco-friendly too. And not only does it save power, it's quiet as well, making it the ideal bench-top companion.



# Optical Spectrum Analyzer MS9740B Panel Layout

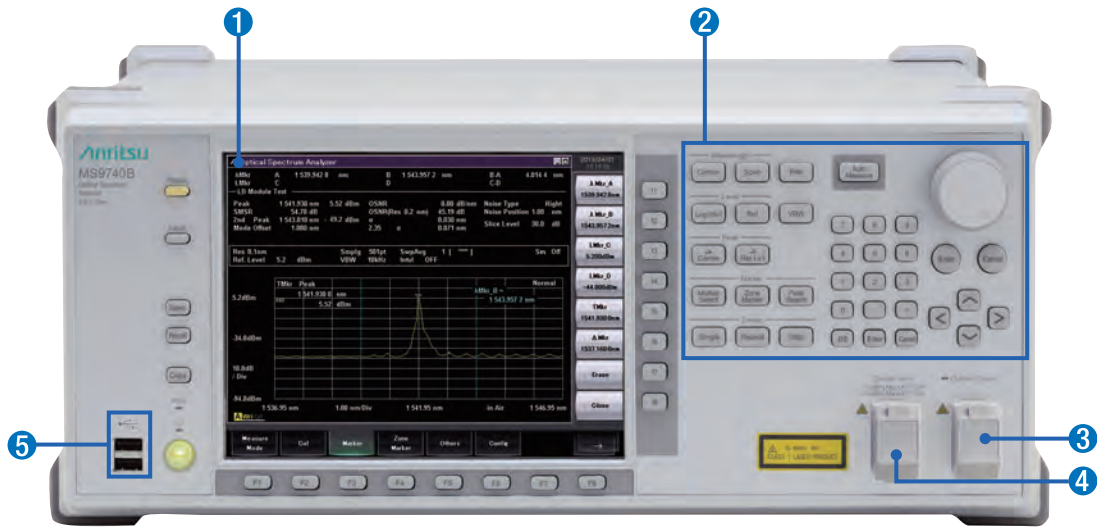

## 1 8.4-inch Liquid Crystal Display (LCD)

Waveforms and results are easy to read on the large display. The familiar Windows GUI makes operation with a mouse easy too.

## 2 Measurement and Shortcut Keys, and Encoder

These keys are used to make settings and perform analysis. Common operations have shortcut keys.

## 3 Light Source for Wavelength Calibration Option (MS9740B-002)

Wavelength measurement can be calibrated to achieve  $\pm 20$  pm accuracy (1520 nm to 1620 nm) by inputting light from this option into the optical input connector.

## 4 Optical Receiver Connector

Both SM and MM fiber connections are supported by exchangeable connector types (FC, SC, ST, DIN).

## 5 USB Port

This connector supports a USB mouse, keyboard or memory (for easy file exchange).

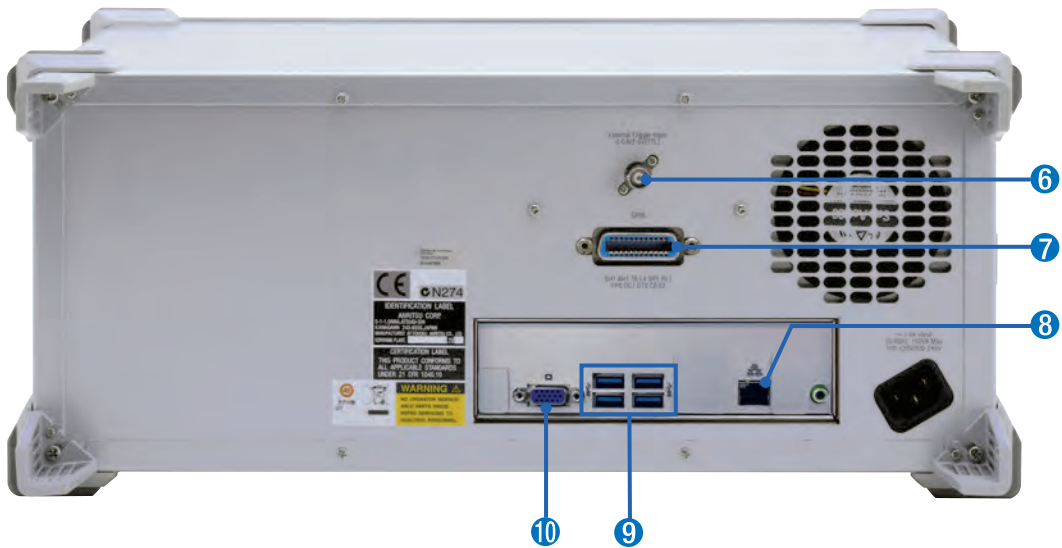

## 6 Trigger Input

This connector is for inputting a synchronous signal.

## 7 GPIB Interface Option (MS9740B-001)

This connector supports external control from a PC over GPIB (Connector is standard implementation).

## 8 Ethernet Interface

This connector supports external control from a PC via Ethernet.

## 9 USB Port

This connector supports a USB mouse, keyboard or memory (for easy file exchange).

## 10 VGA Output

This connector is for an external VGA screen.

# Optical Spectrum Analyzer MS9740B Specifications

## Optical Spectrum Analyzer MS9740B

Supported Optical Fiber	SM fiber (ITU-T G.652), 50 μm/125 μm GI fiber*1, PC Connector (reflection attenuation 40 dB or more)	
Optical Connector	User replaceable: FC, SC, ST, DIN (All connectors are PC polished.)	
Wavelength Measurement Range	600 nm to 1750 nm	
Wavelength Accuracy*2	±20 pm (1520 nm to 1620 nm, Resolution: 0.03 nm to 0.2 nm)*3, ±100 pm (1520 nm to 1620 nm, Resolution: 0.5 nm, 1.0 nm)*3 ±300 pm (600 nm to 1520 nm)*4, ±200 pm (1520 nm to 1570 nm)*4, ±300 pm (1570 nm to 1750 nm)*4	
Wavelength Stability*2	±5 pm (1 min, smoothing: 11 pt, at center wavelength of half maximum, Using SM fiber)	
Wavelength Linearity*2	±20 pm (1520 nm to 1620 nm)	
Setting Resolution	0.03, 0.05, 0.07, 0.1, 0.2, 0.5, 1.0 nm (RBW: 3 dB optical filter: transmission bandwidth)	
Resolution Accuracy*2, *5	±7% (Resolution: 0.1 nm), ±3% (Resolution: 0.2 nm), ±2.2% (Resolution: 0.5 nm) [1520 nm to 1620 nm] ±30% (Resolution: 0.1 nm), ±15% (Resolution: 0.2 nm), ±7% (Resolution: 0.5 nm) [600 nm to 1520 nm, 1620 nm to 1750 nm]	
Measurement Range*2	-65 to +10 dBm (600 nm to 1000 nm), -85 to +10 dBm (1000 nm to 1250 nm), -90 to +10 dBm (1250 nm to 1600 nm), -85 to +10 dBm (1600 nm to 1650 nm), -65 to +10 dBm (1650 nm to 1700 nm), -55 to +10 dBm (1700 nm to 1750 nm) [5°C to 30°C, VBW: 10 Hz, Sweep average: 10, Resolution: 0.07 nm to 1.0 nm, using SM fiber, Optical Att: Off] -60 to +10 dBm (600 nm to 1000 nm), -80 to +10 dBm (1000 nm to 1250 nm), -85 to +10 dBm (1250 nm to 1600 nm), -80 to +10 dBm (1600 nm to 1650 nm), -60 to +10 dBm (1650 nm to 1700 nm), -50 to +10 dBm (1700 nm to 1750 nm) [30°C to 45°C, VBW: 10 Hz, Sweep average: 10, Resolution: 0.07 nm to 1.0 nm, using SM fiber, Optical Att: Off] -70 to +23 dBm (1100 nm to 1600 nm), [5°C to 30°C, VBW: 10 Hz, Sweep average: 10, Resolution: 0.07 nm to 1.0 nm, using SM fiber, Optical Att: On] -65 to +23 dBm (1100 nm to 1600 nm), [30°C to 45°C, VBW: 10 Hz, Sweep average: 10, Resolution: 0.07 nm to 1.0 nm, using SM fiber, Optical Att: On]	
Level Accuracy*2, *6	±0.4 dB (Wavelength: 1310 nm, 1550 nm, Input: -10 dBm, Resolution: 0.1 nm to 1.0 nm)	
Level Stability*2	±0.02 dB (1 min, Wavelength: 1550 nm, Input: -23 dBm, Resolution: 0.1 nm to 1.0 nm, no polarization fluctuation)	
Level Linearity*2	±0.05 dB (Wavelength: 1550 nm, Input: -50 to 0 dBm, Optical Att: Off) ±0.05 dB (Wavelength: 1550 nm, Input: -30 to +20 dBm, Optical Att: On)	
Level Flatness*2, *7	±0.1 dB (Wavelength: 1520 nm to 1620 nm, Resolution: 0.5 nm, Optical Att: Off)	
Polarization Dependency*2	±0.05 dB (Wavelength: 1550 nm/1600 nm), ±0.1 dB (Wavelength: 1310 nm), [Resolution: 0.5 nm, 1.0 nm]	
Dynamic Range*2	High dynamic range: 70 dB (±1 nm from peak wavelength), 60 dB (±0.4 nm from peak wavelength), 42 dB (±0.2 nm from peak wavelength) Normal dynamic range: 62 dB (±1 nm from peak wavelength), 58 dB (±0.4 nm from peak wavelength), 42 dB (±0.2 nm from peak wavelength) [Wavelength: 1550 nm, Resolution: 0.05 nm, Optical Att: Off, 20°C to 30°C]	
Optical Return Loss*2	≥35 dB (Using SM fiber with wavelength of 1300 nm and 1550 nm)	
VBW Setting	1 MHz, 100 kHz, 10 kHz, 2 kHz, 1 kHz, 200 Hz_Fast, 200 Hz, 100 Hz, 10 Hz	
Sweep*2	Sweep width: 0.2 nm to 1200 nm, 0 nm Sweep time: ≤0.2 s (span: 5 nm, Resolution: 0.1 nm), ≤0.3 s (span: 500 nm) [VBW: 10 kHz, Normal dynamic range, center 1550 nm (span: 5 nm), 1200 nm (span: 500 nm), sweep start to stop, no optical input, sampling point: ≤501] Sweep time: 0.35 s/30 nm (typ.) [VBW: 1 kHz-Fast, dynamic range, center 1550 nm, Resolution: 0.1 nm, sweep start to stop, optical input -10 dBm, sampling point: 1001] Sweep time: 1.65 s/30 nm (typ.) [VBW: 200 Hz-Fast, dynamic range, center 1550 nm, Resolution: 0.1 nm, sweep start to stop, optical input -10 dBm, sampling point: 1001]	
Display	800 × 600 dots, 8.4 inch SVGA color LCD	
Function	Measurement functions: Auto Measure, Optical pulse measurement (External trigger), Power monitor Display functions: Normalized, Max Hold, Min Hold, Overlap, Value in Air/Vacuum, Effective Resolution, Multi fiber mode Analysis functions: Wavelength Subtraction, Marker, Wavelength Analysis (Threshold, ndB-Loss, Envelope, RMS, SMSR, Spectrum Power), Light Source Evaluation (FP-LD, DFB-LD, LED, LD Module), Optical AMP NF Evaluation, PMD Measurement, WDM Signal Evaluation, WDM Filter Analysis Calibration functions: Auto Align, Wavelength cal., Level offset, Wavelength offset Memory function: Display measurement data to memory A to J (10 waveforms) Interfaces: Ethernet, GPIB (MS9740B-001) Input/Output function I/O: Save and read files to USB memory Input: External trigger terminal (0 to 0.8 V/2 V to 5 V, high impedance) Output: Measured data text file output, measurement screen file (BMP, PNG) output, VGA output	
Operating Conditions	Operating temperature: +5°C to +45°C, Storage temperature: -20°C to +60°C, Relative humidity: 0 to 90% (no condensation)	
Power Supply	100 V(ac) to 120 V(ac)/200 V(ac) to 240 V(ac), 50 Hz to 60 Hz, ≤75 VA	
Dimensions and Mass	426 (W) × 177 (H) × 350 (D) mm (excluding projections), ≤15.0 kg (without options)	
CE	EMC	2014/30/EU, EN61326-1, EN61000-3-2
	LVD	2014/35/EU, EN61010-1
	RoHS	2011/65/EU, (EU) 2015/863, EN IEC 63000: 2018
UKCA	EMC	S.I. 2016 No.1091, EN 61326-1, EN61000-3-2
	LVD	S.I. 2016 No.1101, EN 61010-1
	RoHS	S.I. 2012 No.3032, EN IEC 63000:2018
Remote Control Interfaces*8	Ethernet, GPIB (MS9740B-001)	
OS	Windows	

\*1: The connection loss when connecting 50 μm/125 μm multimode optical fiber degrades the minimum light reception sensitivity.  
The MS9740B has an MM mode function to correct correction loss when connecting 50 μm/125 μm multimode optical fiber and to display the level. The optical loss level is corrected when the MM mode is On. It corrects the level by 14 dB (sum).  
Level display errors occur if light is input under other excitation conditions.

\*2: Warm-up the instrument for at least 2 hours before measurement by performing repeated sweeping at span ≥ 100 nm, VBW ≥ 10 kHz. Perform waveform calibration after auto-optical alignment (WI Cal) and keep the instrument at the same temperature unless stated otherwise. Use either SM fiber (ITU-T G.652) or GI fiber (50 μm/125 μm) with a return loss of >40 dB, or GI fiber (62.5 μm/125 μm) with a return loss of >38 dB.

\*3: Built-in MS9740B-002, after WI cal (ref) wavelength calibration execution, at stable room temperature

\*4: After WI cal (Ext) wavelength calibration execution by external light source, such as Single Longitudinal mode laser (DFB-LD)

\*5: Effective resolution, after Res-cal, using SM fiber

\*6: Using Anritsu's reference single mode fiber with FC/UPC connector, 23°C ±5°C

\*7: 10°C to 30°C

\*8: When controlling the MS9740B remotely using the Ethernet port, a VISA\*9 driver must be installed in the PC controller. We recommend using NI-VISA™\*10 from National Instruments™ (NI hereafter) as the VISA driver.  
Although a license is generally required to use NI-VISA™, the licensed NI-VISA™ driver is provided free-of-charge for use when performing remote control (Note) of a MS9740B unit in which the GPIB option MS9740B-001 has been installed.

The NI-VISA™ driver can be downloaded from the NI website at:

<http://sine.ni.com/psp/app/doc/p/id/psp-411>

Be sure to comply with the NI license agreement for the usage and license scope. Be sure to uninstall the NI-VISA™ driver when disposing of the MS9740B or transferring it to a third party, etc., or when ceasing to use NI-VISA™.

(Notes)

Although the NI-VISA™ driver itself can be downloaded free-of-charge from the web, an implementation license is required for legal reasons if some requirements are not met. (Check the NI web page for the detailed requirements.)

If these requirements are not met, permission is not granted to use NI hardware and software and an NI implementation license must be purchased. However, since the GPIB option MS9740B-001 incorporates NI hardware (GPIB ASIC), the NI-VISA™ driver can be used free-of-charge.

Glossary of Terms:

\*9: VISA: Virtual Instrument Software Architecture  
I/O software specification for remote control of measuring instruments using interfaces such as GPIB, Ethernet, USB, etc.

\*10: NI-VISA™

World de facto standard I/O software interface developed by NI and standardized by the VXI Plug&Play Alliance.

Trademarks: National Instruments™, NI™, NI-VISA™ and National Instruments Corporation are all trademarks of National Instruments Corporation.

# Optical Spectrum Analyzer MS9740B Specifications

## Multimode Fiber Interface (50/62.5 μm) MS9740B-009

Supported Optical Fiber	SM fiber (ITU-T G.652), 50 μm/125 μm GI fiber*1, 62.5 μm/125 μm GI fiber*1, PC Connector SM (ITU-T G.652), GI (50 μm/125 μm): reflection attenuation 40 dB or more, GI (62.5 μm/125 μm): reflection attenuation 38 dB or more
Optical Connector	User replaceable: FC, SC, ST, DIN (All connectors are PC polished.)
Wavelength Measurement Range	600 nm to 1750 nm
Wavelength Accuracy*2	±50 pm (1530 nm to 1570 nm)*3, ±100 pm (1530 nm to 1570 nm)*4 ±300 pm (600 nm to 1750 nm)*5
Wavelength Stability*2	±5 pm (1 min, smoothing: 11 pt, at center wavelength of half maximum, Using SM fiber)
Setting Resolution	0.07, 0.1, 0.2, 0.5, 1.0 nm (RBW: 3 dB optical filter: transmission bandwidth)
Resolution Accuracy*2	±30% (Resolution: 0.1 nm), ±15% (Resolution: 0.2 nm), ±7% (Resolution: 0.5 nm) After Res-cal, using SM fiber, 633/1310/1550 nm
Measurement Range*2	-65 to +10 dBm (600 nm to 1000 nm), -85 to +10 dBm (1000 nm to 1250 nm), -90 to +10 dBm (1250 nm to 1600 nm), -75 to +10 dBm (1600 nm to 1700 nm), -55 to +10 dBm (1700 nm to 1750 nm) [5°C to 30°C, VBW: 10 Hz, Sweep average: 10, Resolution: 0.07 nm to 1.0 nm, using SM fiber, Optical Att: Off] -60 to +10 dBm (600 nm to 1000 nm), -80 to +10 dBm (1000 nm to 1250 nm), -85 to +10 dBm (1250 nm to 1600 nm), -70 to +10 dBm (1600 nm to 1700 nm), -50 to +10 dBm (1700 nm to 1750 nm) [30°C to 45°C, VBW: 10 Hz, Sweep average: 10, Resolution: 0.07 nm to 1.0 nm, using SM fiber, Optical Att: Off] -70 to +23 dBm (1100 nm to 1600 nm), [5°C to 30°C, VBW: 10 Hz, Sweep average: 10, Resolution: 0.07 nm to 1.0 nm, using SM fiber, Optical Att: On] -65 to +23 dBm (1100 nm to 1600 nm), [30°C to 45°C, VBW: 10 Hz, Sweep average: 10, Resolution: 0.07 nm to 1.0 nm, using SM fiber, Optical Att: On]
Level Accuracy*2	±0.6 dB (Wavelength: 1310 nm, 1550 nm, Input: -10 dBm, Resolution: 0.2 nm to 1.0 nm, using SM fiber, using Anritsu's reference single mode fiber with FC/UPC connector, 23°C ±5°C)
Level Stability*2	±0.1 dB (1 min, Wavelength: 1550 nm, Input: -23 dBm, Resolution: 0.2 nm to 1.0 nm, no polarization fluctuation, using SM fiber, at stable room temperature)
Level Linearity*2	±0.1 dB (Wavelength: 1550 nm, Input: -50 to 0 dBm, using SM fiber, Optical Att: Off) ±0.1 dB (Wavelength: 1550 nm, Input: -30 to +20 dBm, using SM fiber, Optical Att: On)
Dynamic Range*2	High dynamic range: 70 dB (±1 nm from peak wavelength, 20°C to 30°C), 60 dB (±0.5 nm from peak wavelength, 20°C to 30°C) 65 dB (±1 nm from peak wavelength, 5°C to 45°C), 55 dB (±0.5 nm from peak wavelength, 5°C to 45°C) Normal dynamic range: 62 dB (±1 nm from peak wavelength, 20°C to 30°C), 58 dB (±0.5 nm from peak wavelength, 20°C to 30°C) 57 dB (±1 nm from peak wavelength, 5°C to 45°C), 53 dB (±0.5 nm from peak wavelength, 5°C to 45°C) [Wavelength: 1550 nm, Resolution: 0.07 nm, using SM fiber, Optical Att: Off]
Optical Return Loss*2	≥32 dB (Wavelength: 1310 nm, 1550 nm, using SM fiber)
VBW Setting	1 MHz, 100 kHz, 10 kHz, 2 kHz, 1 kHz_Fast, 1 kHz, 200 Hz_Fast, 200 Hz, 100 Hz, 10 Hz
Sweep*2	Sweep width: 0.2 nm to 1200 nm, 0 nm Sweep time: ≤0.2 s (span: 5 nm, Resolution: 0.1 nm), ≤0.3 s (span: 500 nm) [VBW: 10 kHz, Normal dynamic range, center 1550 nm (span: 5 nm), 1200 nm (span: 500 nm), sweep start to stop, no optical input, sampling point: ≤501] Sweep time: 0.35 s/30 nm (typ.) [VBW: 1 kHz_Fast, dynamic range, center 1550 nm, Resolution: 0.1 nm, sweep start to stop, optical input -10 dBm, sampling point: 1001] Sweep time: 1.65 s/30 nm (typ.) [VBW: 200 Hz_Fast, dynamic range, center 1550 nm, Resolution: 0.1 nm, sweep start to stop, optical input -10 dBm, sampling point: 1001]

See MS9740B specifications page for Display, Function, Operating Conditions, Power Supply, Dimension and Mass, CE, Remote control Interfaces and OS.

\*1: The NA is 0.2 for 50 μm/125 μm GI fiber and 0.275 for 62.5 μm/125 μm GI fiber.

\*2: Warm-up the instrument for at least 2 hours before measurement by performing repeated sweeping at span ≥100 nm, VBW ≥10 kHz. Perform waveform calibration after auto-optical alignment (WI Cal) and keep the instrument at the same temperature unless stated otherwise. Use either SM fiber (ITU-T G.652) or GI fiber (50 μm/125 μm) with a return loss of >40 dB, or GI fiber (62.5 μm/125 μm) with a return loss of >38 dB.

\*3: Built-in MS9740B-002, after WI Cal (Ref), with SM fiber and resolution at 0.07 nm to 0.2 nm

\*4: Built-in MS9740B-002, after WI Cal (Ref), with SM fiber and resolution at 0.5 nm/1.0 nm

\*5: After WI cal (Ext) wavelength calibration execution by external light source, such as DFB-LD, using SM fiber or GI fiber (50 μm/125 μm or 62.5 μm/125 μm)

## Pulsed Light Measurement MS9740B-020

SMSR Reproducibility	±1.4 dB (MS9740B), ±1.8 dB (with MS9740B-009 installed) Using SM fiber and DFB-LD with 1550 nm wavelength at 10 dBm peak power input, with 45 dB max SMSR and no change in polarization conditions Pulse conditions: 5 kHz min repetition frequency and 1% min Duty Pulse Mode enabled, 1 kHz VBW, 0.1 nm Setting Resolution, 10 nm max span, 501 sampling points, at 23°C ±5°C
----------------------	--

## Light Source for Wavelength Calibration MS9740B-002

Supported Optical Fiber	SM fiber (ITU-T G.652)
Optical Connector	User replaceable: FC, SC, ST, DIN (All connectors are PC polished.)
Output Level	-40 dBm/nm (Reference wavelength, 10°C to 30°C, Wavelength: 1550 nm ±20 nm, Resolution: 1 nm)
Output Level Stability	±0.04 dB (10 minutes after power-on, Wavelength: 1550 nm, Resolution: 1 nm, VBW: 100 Hz, Point Avg.: 20, Measurement time: 1 minute)
Laser Safety*	Class 1 (IEC 60825-1: 2007)

\*: Safety measures for laser products. This option complies with optical safety standards in Class 1 of IEC 60825-1; The following descriptive labels are affixed to the product.



# Optical Spectrum Analyzer MS9740B Ordering Information

Please specify the model/order number, name and quantity when ordering.

The names listed in the chart below are Order Names. The actual name of the item may differ from the Order Name.

## (1) Specify the mainframe

Model/Order No.	Name
MS9740B	<b>Main Frame</b> Optical Spectrum Analyzer
Z2024A*1	<b>Standard Accessories</b> MS9740B Operation Manual (CD): 1 pc Power Cord: 1 pc

## (2) Specify one optical connector

Model/Order No.	Name
MS9740B-037	<b>Options (Optical Connector)*2</b> FC Connector
MS9740B-038	ST Connector
MS9740B-039	DIN 47256 Connector
MS9740B-040	SC Connector

## (3) Select an option from the list

Model/Order No.	Name
MS9740B-001	<b>Options (Interface)</b> GPIB Interface
MS9740B-101	GPIB Interface Retrofit
MS9740B-002	<b>Options (Light Source for Wavelength Calibration)*3, *4</b> Light Source for Wavelength Calibration
MS9740B-102	Light Source for Wavelength Calibration Retrofit
MS9740B-009	<b>Option (Multimode Fiber Interface)*5, *6</b> Multimode Fiber Interface (50/62.5 μm)
MS9740B-020*7	<b>Option (Pulsed Light Measurement)</b> Pulsed Light Measurement
MS9740B-108*8	<b>Option (Windows OS)</b> OS Upgrade to Win10 Retrofit

## (4) Select the application parts, peripherals and consumables from the list

Model/Order No.	Name
W3998AE	<b>Application Parts</b> MS9740B Optical Spectrum Analyzer
W3999AE	Operation Manual (Printed)
W4000AE	MS9740B Optical Spectrum Analyzer
J0617B*9	Remote Control Operation Manual (Printed)
J0618D*9	MS9740B Optical Spectrum Analyzer
J0618E*9	Remote Control Operation Manual (Printed)
J0619B*9	MS9740B Optical Spectrum Analyzer
J1530A	Remote Control Operation Manual (Printed)
J1532A	MS9740B Optical Spectrum Analyzer
J0635B	Replaceable Optical Connector (FC-PC)
J0660B	Replaceable Optical Connector (ST)
J0893A	Replaceable Optical Connector (DIN)
J0893B	Replaceable Optical Connector (SC)
J1534A	SC Plug-in Converter (UPC(P)-APC(J))
Z0914A	FC Plug-in Converter (UPC(P)-APC(J))
Z0915A	FC · PC-FC · PC-2M-SM (Optical Fiber Cord, 2.0 m)
Z0284	SC · PC-SC · PC-2M-SM (Optical Fiber Cord, 2.0 m)
B0640C*10	FC · PC-FC · PC-1M-GI (Optical Fiber Cord, 1.0 m)
B0671A*11	FC · PC-FC · PC-2M-GI (Optical Fiber Cord, 2.0 m)
B0641A	LC-SC Plug-in Converter (for SM, SC(P)-LC(J))
J0008	Ferrule Cleaner
Z0541A	Replacement Reel for Ferrule Cleaner
Z0975A	Adapter Cleaner (Stick Type)
	Carrying Case
	Front Cover for 1MW4U
	Rack Mount Kit
	GPIB Cable, 2.0 m
	USB Mouse
	Keyboard (USB)

\*1: CD contains Operation Manual for Main Frame and Remote Control.

\*2: One free specified optical connector for optical input port.

\*3: When MS9740B-002 selected, one more connector specified in (2) supplied free.

\*4: Executing wavelength calibration with this option secures ±20 pm (1520 nm to 1620 nm, without MS9740B-009) accuracy. The MS9740B supports wavelength calibration with the external light source, such as DFB-LD, but this option assures higher accuracy. Refer to the specifications for details.

\*5: Factory option and Retrofit not supported.

\*6: Optical Spectrum Analyzer MS9740B standard not guaranteed.

Refer to Multimode Fiber Interface Option MS9740B-009 Standard.

\*7: Retrofit supported as charged software option. However, retrofit number is Option-320. When retrofitting this option, also specify either the following storage media or Web download.

Model/Order No.	Name
Z2163A	USB Stick for Retrofit Options

\*8: This option upgrades the Windows Embedded Standard 7 to the Windows 10 Enterprise LTSC. It is performed by Anritsu factory or service center return.

\*9: Exchangeable-type optical connectors for optical input port and wavelength calibration light source output port.

\*10: The Carrying Case includes a Front Panel Protective Cover (B0671A).

\*11: Old type carrying case cannot be used (B0640B).

### Ordering Configuration 1

- |                 |   |
|-----------------|---|
| (1) MS9740B     | Optical Spectrum Analyzer               |
| (2) MS9740B-040 | SC Connector                            |
| (3) MS9740B-001 | GPIB Interface                          |
| (3) MS9740B-002 | Light Source for Wavelength Calibration |
| (4) J0617B      | Optical Connector Adapter (FC) × 2 pcs  |

• When ordering the main frame, specify model name (1) and one connector from (2).

• Two SC connectors specified in (2) supplied free when light source for wavelength calibration option selected in (3).

### Ordering Configuration 2

- |                 |   |
|-----------------|---|
| (1) MS9740B     | Optical Spectrum Analyzer               |
| (2) MS9740B-037 | FC Connector                            |
| (3) MS9740B-002 | Light Source for Wavelength Calibration |
| (3) MS9740B-009 | Multimode Fiber Interface (50/62.5 μm)  |
| (3) MS9740B-020 | Pulsed Light Measurement                |

• When ordering the main frame, specify model name (1) and one connector from (2).

• Two FC connectors specified in (2) supplied free when light source for wavelength calibration option selected in (3).

• When MS9740B-009 specified with (3): specifications based on MS9740B-009.

# 4TECT

ООО «4TECT»

Телефон: +7 (499) 685-4444

info@4test.ru

www.4test.ru